



HOW TO MAKE A HOME RUN.™

Use And Care

G U I D E



Table of Contents (complete)	2
A Note to You	3
Important Safety Instructions	4-6
Parts and Features	7
Using Your Range	8
Using the Self-Cleaning Cycle	25
Caring for Your Range	29
If You Need Assistance or Service	33
Warranty	36

1-800-253-1301

Call us with questions or comments.

SELF-CLEANING ELECTRIC SLIDE-IN RANGE

MODEL RS386PXE

PART NO. 229C4020P026-1/4389867

Table of Contents

	Page		Page
A Note to You	3	Energy saving tips	19
Important Safety Instructions	4-6	Using the electronic MEALTIMER™ control	19
Parts and Features	7	The oven vent	23
Using Your Range	8	The storage drawer	23
Using the surface units	8	The anti-tip bracket	24
Positioning racks and pans	10	Using the Self-Cleaning Cycle	25
For best air circulation	11	Before you start	25
Using aluminum foil for baking.....	11	Setting the controls	26
The electronic oven control.....	12	Special tips	28
Setting the clock	13	How the cycle works	28
Using the electronic Minute Timer	13	Caring for Your Range	29
Using the off/cancel pad	14	Cleaning the cooktop	29
Audible signals.....	14	Cleaning other range parts	31
Baking/roasting	15	The oven light	32
Adjusting the oven temperature control	16	If You Need Assistance or Service	33
Broiling	17	Warranty	36
Broiling tips	18		

A Note to You

Thank you for buying a WHIRLPOOL® appliance.

Because your life is getting busier and more complicated, WHIRLPOOL ranges are easy to use, save time, and help you manage your home better. To ensure that you enjoy years of trouble-free operation, we developed this Use and Care Guide. It is full of valuable information about how to operate and maintain your appliance properly and safely. Please read it carefully.

Also, please complete and mail in the Ownership Registration Card provided with your appliance. The card helps us notify you about any new information on your appliance.

Please record your model's information.

Whenever you call our Consumer Assistance Center at **1-800-253-1301** or request service for your appliance, you need to know your complete model number and serial number. You can find this information on the model and serial number plate (see diagram on page 7 for location of plate).

Please also record the purchase date of your appliance and your dealer's name, address, and telephone number.

Model Number _____

Serial Number _____

Purchase Date _____

Dealer Name _____

Dealer Address _____

Dealer Phone _____

Keep this book and the sales slip together in a safe place for future reference.

**Our Consumer Assistance
Center number is toll-free.**

1-800-253-1301

Important Safety Instructions

Your safety is important to us.

This guide contains safety symbols and statements. Please pay special attention to these symbols and follow any instructions given. Here is a brief explanation of the use of the symbol.



This symbol alerts you to hazards such as fire, electrical shock, or other injuries.

WARNING

To reduce the risk of fire, electrical shock, injury to persons, or damage when using the range, follow basic precautions, including the following:

General

- Read all instructions before using the range.
- Install or locate the range only in accordance with the provided Installation Instructions. The range must be installed by a qualified installer. The range must be properly connected to electrical supply and grounded.



- **WARNING:** To reduce the risk of tipping the appliance, the appliance must be secured by a properly installed anti-tip bracket. To check if the bracket is installed properly, see “The anti-tip bracket” on page 24.
- **CAUTION:** Do not store things children might want above the range. Children could be burned or injured while climbing on it.
- Do not leave children alone or unattended in area where the range is in use. They should never be allowed to sit or stand on any part of the range. They could be burned or injured.

- Do not operate the range if it is damaged or not working properly.
- Do not use the range for warming or heating the room. Persons could be burned or injured, or a fire could start.
- Use the range only for its intended use as described in this manual.



- Do not touch surface units, areas near units, heating elements, or interior surfaces of oven. Surface units and heating elements may be hot even though they are dark in color. Areas near surface units and interior surfaces of an oven become hot enough to cause burns. During and after use, do not touch, or let clothing or other flammable materials contact surface units, areas near units, heating elements, or interior surfaces of oven until they have had sufficient time to cool. Other surfaces of the range, such as the oven vent opening, the surface near the vent opening, the cooktop, and the oven door and

window, could also become hot enough to cause burns.



- Do not wear loose or hanging garments when using the range. They could ignite if they touch a hot surface unit and you could be burned.
- Use only dry pot holders. Moist or damp pot holders on hot surfaces could result in burns from steam. Do not let pot holder touch hot heating elements. Do not use a towel or bulky cloth for a pot holder. It could catch on fire.
- Keep range vents unobstructed.
- Do not heat unopened containers. They could explode. The hot contents could cause burns and container particles could cause injury.
- Use only cookware approved for oven use. Follow cookware manufacturer's instructions, especially when using glass or plastic cookware.
- Do not store flammable materials on or near the range. The fumes could create an explosion and/or fire hazard.

When using the cooktop

- Do not cook on a broken cooktop. If cooktop should break,

cleaning solutions and spillovers could penetrate the broken cooktop and create a risk of electrical shock. Contact a qualified technician immediately.

- Select a pan with a flat bottom that is about the same size as the surface unit. If pan is smaller than the surface unit, some of the heating element will be exposed and could result in the igniting of clothing or pot holders. Correct pan size also improves cooking efficiency.
- Check to be sure glass cookware is safe for use on the range. Only certain types of glass, glass-ceramic, ceramic, earthenware, or other glazed cookware are suitable for cooktops without breaking due to the sudden change in temperature.
- Never leave surface units unattended at high heat settings. A boilover could result and cause smoking and greasy spillovers that could ignite.



- Turn pan handles inward, but not over other surface units. This will help reduce the chance of burns, igniting of flammable materials, and spills due to bumping of the pan.

When using the oven

- Always position oven rack(s) in desired location while oven is cool. If a rack must be removed while oven is hot, do not let pot holder contact hot heating elements in oven.
- Use care when opening oven door. Let hot air or steam escape before removing or replacing food.

Grease

- Grease is flammable. Do not allow grease to collect around cooktop or in vents. Wipe spills immediately.



- Do not use water on grease fires. Never pick up a flaming pan. Smother flaming pan on range by covering with a well-fitting lid, cookie sheet, or flat tray. Flaming grease outside of pan can be extinguished with baking soda or, if available, a multipurpose dry chemical or foam-type extinguisher.

Care and cleaning

- Clean cooktop with care. Some cleaners could produce noxious fumes if applied to a hot surface. If a wet paper towel is used to wipe spills on a hot cooking area, be careful to avoid steam burns.

- Small amounts of formaldehyde and carbon monoxide are given off in the Self-Cleaning cycle from fiberglass insulation and food decomposition. Significant exposure to these substances could cause cancer or reproductive harm. Exposure can be minimized by venting with a hood or open window and wiping out excess food spills prior to self-cleaning.



- Do not use oven cleaners. No commercial oven cleaner or oven liner protective coating of any kind should be used in or around any part of the oven.
- Before self-cleaning the oven, remove broiler pan, broiler grid, oven racks, and other cookware. Do not use your oven to clean miscellaneous parts unless you are instructed to do so in this Use and Care Guide.
- Do not clean door heat seal. It is essential for a good seal. Care should be taken not to rub, damage, or move the seal. Clean only parts recommended in this Use and Care Guide.
- Do not repair or replace any part of the range unless specifically recommended in this manual. All other servicing should be referred to a qualified technician.
- Disconnect the electrical supply before servicing the range.

– SAVE THESE INSTRUCTIONS –

Parts and Features

This section contains captioned illustrations of your range. Use them to become familiar with the location and appearance of all parts and features. To help you find information on specific parts or features quickly, page references are included.

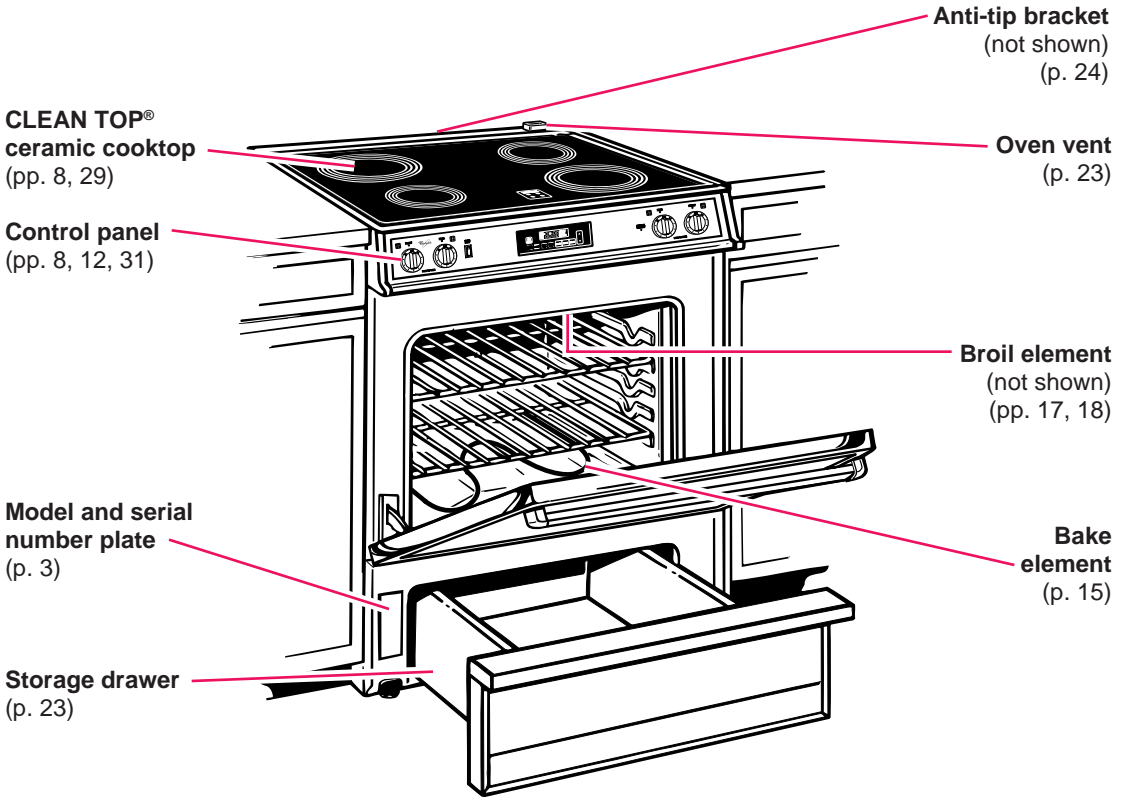

Control panel

Surface unit markers
(p. 8)

Manual oven light switch
(p. 32)

Electronic oven control
(p. 12)

Surface heating indicator light
(p. 8)

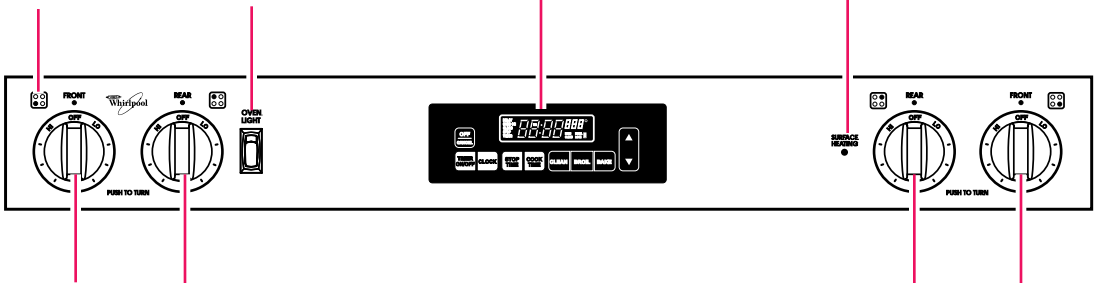

Left front control knob
(p. 8)

Left rear control knob
(p. 8)

Right rear control knob
(p. 8)

Right front control knob
(p. 8)

Using Your Range

To get the best cooking results, you should use your range the correct way. This section tells you what you need to know to use your range safely and efficiently.

Using the surface units

Push in control knobs before turning them to a setting. You can set them anywhere between HI and OFF.

Surface unit markers

The solid dot in the surface unit marker shows which surface unit is turned on by that knob.

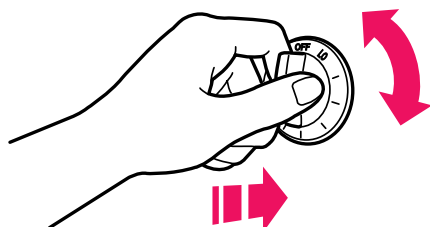

Surface heating indicator light

The Surface Heating Indicator Light on the control panel will glow when a surface unit is turned on.

Hot surface indicator lights

The Hot Surface Indicator Lights on the cooktop surface will glow when the surface units are turned on. The Indicator Lights will continue to glow as long as the surface units are too hot to touch, even after they are turned off.

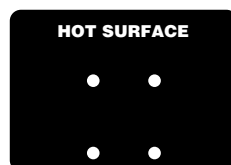

⚠ WARNING



Fire Hazard

Turn all controls off when done cooking.

Failure to do so can result in death, fire, or burns.

SETTING	RECOMMENDED USE
HI	<ul style="list-style-type: none">• To start foods cooking.• To bring liquids to a boil.
Medium-high	<ul style="list-style-type: none">• To hold a rapid boil.• To fry chicken or pancakes.
Medium (opposite OFF)	<ul style="list-style-type: none">• For gravy, pudding, and icing.• To cook large amounts of vegetables.
Medium-low	<ul style="list-style-type: none">• To keep food cooking after starting it on a higher setting.
LO	<ul style="list-style-type: none">• To keep food warm until ready to serve.

Until you get used to the settings, use the chart at right as a guide. For best results, start cooking at the high setting; then turn the control knob down to continue cooking.

Using the ceramic glass cooktop

Cooking on the ceramic glass cooktop is almost the same as cooking on coil surface units. There are, however, a few differences:

- **The surface unit will glow red** when it is turned on. You will see the element cycling on (glowing red) and off – even on HI setting – to maintain the proper temperature setting you have selected.
- **Sliding metal pans** on ceramic glass cooktop surface could leave marks. Wiping off the cooktop before and after each use will help keep the surface free from stains and provide the most even heating. See pages 29 and 30 for care and cleaning suggestions.

Cookware tips

- **Select a pan** that is about the same size as the surface unit.
- **NOTE: For best results and greater energy efficiency**, use only flat-bottomed cookware that makes good contact with the surface units. Cookware with rounded, warped, ribbed (such as some porcelain enamelware) or dented bottoms could cause uneven heating and poor cooking results.

You can, however, use the newer cookware available with slightly indented bottoms or very small expansion channels. This cookware is specially designed to provide the good contact needed for best cooking results.

Also, woks, canners, and teakettles with flat bottoms suitable for use on your cooktop are now available in most stores that sell housewares.

- **The pan** should have straight sides and a tight-fitting lid.
- **Choose medium to heavy gauge** (thickness) pans that are fairly lightweight.

- **The pan material** (metal or glass) affects how fast heat transfers from the surface unit through the pan material and how evenly heat spreads over the pan bottom. Choose pans that provide the best cooking results.
- **Handles** should be made of sturdy, heat-resistant material and be securely attached to the pan.
- **With your hand**, feel the bottom of your pans while they are cool for nicks and scratches. Nicks and scratches on pan bottoms will scratch the ceramic glass cooktop.
- **Make sure bottoms** of pans are clean and dry before using on cooktop.
- **Avoid spillovers** on cooktop. Use pans with tall sides.
- **Do not** cook food directly on cooktop.

NOTE: Do not leave empty cookware, or cookware which has boiled dry, on a hot surface unit. The cookware could overheat and damage the cookware or surface unit.

Home canning information

- **Use the largest surface unit** for best results. Also, use a canner/pan which can be centered over the surface unit.
- **Start with hot water.** This reduces the time the control is set on high. Reduce heat setting to lowest position needed to keep water boiling.
- **Refer** to your canner manual for specific instructions.

Positioning racks and pans

To remove racks:

1. Pull rack toward you.
2. Tilt up front end.
3. Pull rack out.

To replace racks:

1. Place rack on rack guides.
2. Tilt up front end.
3. Push rack in until it clears the stop.
4. Lower front and push rack in the rest of the way.

General guidelines

- Before turning on the oven, place oven racks where you need them.
- Be sure the rack(s) is level.
- Use pot holders or oven mitts to protect your hands if rack(s) must be moved while the oven is hot.
- For baking/roasting with 1 rack, place the rack so the top of the food will be centered in the oven.
- When baking/roasting on 2 racks, arrange racks on the bottom and 3rd level from the bottom.
- Do not place items on the oven door when it is open.

Rack placement for specific foods:

FOOD	RACK POSITION
Frozen pies, large roasts, turkeys, angel food cake	Lowest level or 2nd level from bottom
Bundt cakes, most quick breads, yeast breads, casseroles, meats	2nd level from bottom
Cookies, biscuits, muffins, cakes, nonfrozen pies	2nd or 3rd level from bottom

NOTE: For recommended rack placement when broiling, see “Broiling rack position chart” on page 18.

Bakeware tips

- When baking with insulated cookie sheets or baking pans, place them in the bottom third of the oven. You may need to increase the recommended baking times, so test for doneness before removing from the oven.
- For most baking, reduce the oven temperature by 25°F, but use the same baking time when using ovenproof glassware or dark pans. These pans absorb heat, producing darker bottom browning and crispier crusts. When baking pies and bread, you can use the temperature called for in the recipe.

For best air circulation

Hot air must circulate around the pans in the oven for even heat to reach all parts of the oven. This results in better baking.

- **Place** the pans so that one is not directly over the other.
- **For best results, allow** 1½ to 2 inches (4-5 cm) of space around each pan and between pans and oven walls.
- **Use** only one cookie sheet in the oven at a time.

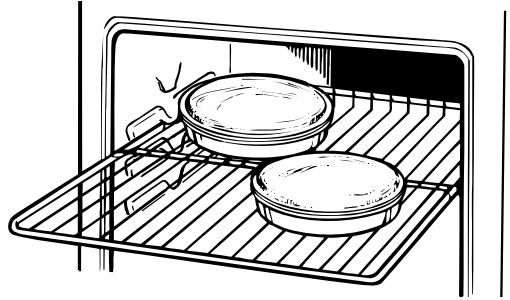

Use the following as a guide to determine where to place the pans:

1 pan

Place in the center of the oven rack.

2 pans

Place in opposite corners of the oven rack.

3 or 4 pans

Place in opposite corners on each oven rack. Stagger pans so no pan is directly over another.

Using aluminum foil for baking

Use aluminum foil to catch spillovers from pies or casseroles:

- **Place** the foil on the oven rack below the rack with the food. **Turn up** foil edges and **make sure** foil is about 1 inch (3 cm) larger all around than the dish holding the food.
- **Do not cover** the entire rack with aluminum foil. It will reduce air circulation and cause poor cooking results.
- **Do not line** oven bottom or entire oven rack with foil or other liners. It could affect the quality of your baking.

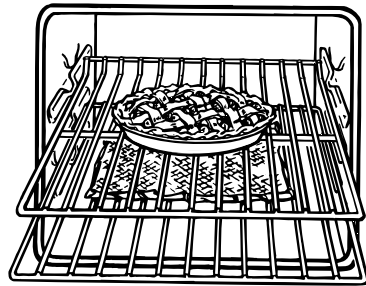

The electronic oven control

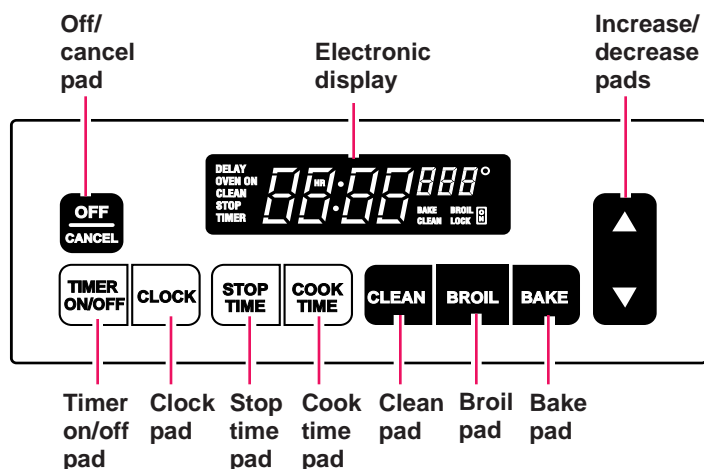

Display/clock

- **When you first plug in the range**, a time of day and “PF” will appear in the temperature display. If, after you set the clock (page 13), “PF” again appears on the display, your electricity was off for a while. Reset the clock.
- **When you are using the oven or Minute Timer**, the display will show times, temperature settings, and what command pads have been pressed.
- **When showing the time of day**, the display will show the hour and minutes.
- **When you are using the Minute Timer**, the display will show minutes and seconds in the following sequence:
 - **For settings under 1 minute**, the display will count down each second.
 - **For settings from 1-10 minutes**, the display will count down minutes and seconds.
- **When you are using Cook Time and/or Stop Time**, the display will show hours and minutes.

Command pads

The command pads tell the oven what to do and in what order. A few examples:

- **Clock** tells the oven you are going to set the clock.
- **Off/Cancel** tells the oven to turn off.
- **Increase/Decrease pads** change time or temperature. Press them briefly to change time or temperature by a small amount. Press and hold to change by a larger amount.

Setting the clock

The clock must be set for the automatic oven timing functions to work properly.

1. **Press** the Clock pad.



2. **Use** the Increase/Decrease pads to set the time of day. **Press** the “up” (▲) or “down” (▼) pad until the correct time shows on the display.

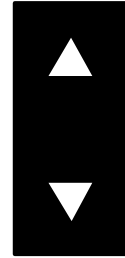

3. **Press** the Clock pad.

NOTES:

- **You cannot change** time of day during a Time Bake or Self-Cleaning cycle.
- **You can see** current time of day while another function is running by pressing the Clock pad.



Using the electronic Minute Timer

The Minute Timer does not start or stop the oven. It works like a kitchen timer. It can be set in hours and minutes up to 9 hours, 55 minutes.

1. **Press** the Timer On/Off pad.



2. **Use** the Increase/Decrease pads to set the desired time. **Press** the “up” (▲) or “down” (▼) pad until the correct time shows on the display. The Minute Timer will start automatically within a few seconds after you release the pad.

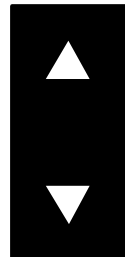

continued on next page

After the countdown is over, three short tones will sound, followed by one tone that sounds every 6 seconds until you press any other command pad.

To reset the Minute Timer:

Repeat Steps 1 and 2 on page 13.

To cancel the Minute Timer:

Press Timer On/Off pad until TIMER stops flashing on the display (about 4 seconds).



Using the off/cancel pad

The Off/Cancel pad will cancel any function except for the Clock and Timer functions. When you press the Off/Cancel pad, the display will show the time of day or, if Minute Timer is also being used, the time remaining.



Audible signals

Audible signals tell you if a function is entered correctly or not. They also tell you when a cycle is completed.

To shut off repeating end-of-timer countdown signal:

1. **Press and hold** the Off/Cancel pad for 10 seconds.
2. A short tone will sound to tell you the signal has been changed.

Repeat the above steps to turn the signal back on.

Baking/roasting

1. **Position** the rack(s) properly before turning on the oven. For further information, **see** "Positioning racks and pans" on page 10.
2. **Press** the Bake pad. The last oven temperature to be set appears on the display.
3. **To cook at a different temperature, use** the Increase/Decrease pad(s). **Press** ▲ to raise the temperature or ▼ to lower the temperature. **Use** these pads until the desired temperature shows on the small display.
4. **When the oven starts to heat, ON** and the changing temperature (starting at 100°F) will be displayed. When the oven reaches the set temperature, a tone will sound.
NOTE: You can change the temperature setting any time during the Bake cycle by repeating Steps 2 and 3 above.
5. **When baking, preheat** the oven. (Preheating is not needed when roasting.) The oven is preheated when you hear a 1-second tone.
6. **Put** food in the oven. During baking/roasting, the elements will turn on and off to keep the oven temperature at the setting.
NOTE: The top element helps heat during baking/roasting, but does not turn red.
7. **When baking/roasting is done, press** the Off/Cancel pad. The time of day will show on the display and all other displays will go off.

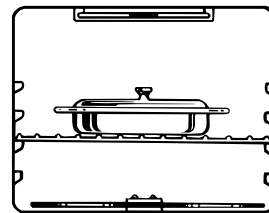
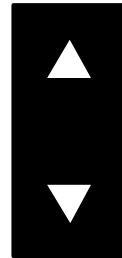

Adjusting the oven temperature control

Although your new oven is properly adjusted to provide accurate temperatures, it may cook faster or slower than your old oven.

If, after using the oven for a period of time, you are not satisfied with the baking/roasting results, you can change the temperature calibration by following these steps:

1. **Press** the Bake pad.



2. **Select** an oven temperature between 500°F and 550°F.

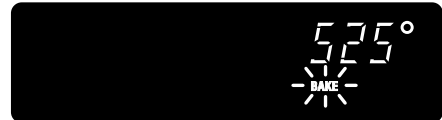

3. **Before BAKE stops flashing, press and hold** the Bake pad for about 4 seconds until the red display changes to the oven adjustment display.



4. **To adjust the temperature, use** the Increase/Decrease pad(s). **Press** ▲ to raise the temperature or ▼ to lower the temperature. You can set the temperature change as much as -35°F cooler or +35°F hotter.



5. **After making the desired adjustment, press** the Off/Cancel pad to enter the new offset temperature.



Broiling

1. **Position** the rack before turning the oven on. **See** “Broiling rack position chart” on page 18.
2. **Put** the broiler pan and food on the rack.
3. **Close** the door to the Broil Stop position (open about 4 inches [10 cm]). The door will stay open by itself.
4. **Press** the Broil pad.



5. **Select** LO Broil (450°F) by pressing the Increase (▲) pad once. Select HI Broil (550°F) by pressing the Increase (▲) pad twice.



NOTE: You can change the temperature setting any time during the Broil cycle by repeating Steps 4 and 5 above.

6. **When broiling is done, press** the Off/Cancel pad. The time of day will show on the display and all other displays will go off. Serve food immediately and leave the broiler pan outside oven to cool during the meal for easiest cleaning.



To broil at a lower temperature:

- **If food is cooking too fast or you want to broil slower from the start**, press the Broil pad and press the Decrease pad once. This temperature setting allows the broil heating element to cycle and provides slow cooking.
- **Fish and chicken** are some foods that may cook better if you use lower broiling temperatures.



NOTE: Leave the oven door partly open whenever using the oven to broil. This allows the oven to maintain proper temperatures.

Broiling rack position chart

RACK POSITION FROM BOTTOM	TYPE OF FOOD/DONENESS
4	Hamburger patties and thin steaks, 1/2" thick or less
3	Quickly searing food, rare and medium steaks, medium patties, ham slices, fish steaks, frankfurters
2	Well-done steaks and patties, lamb chops, split chicken, pork steaks and chops, whole fish
1	Not used for broiling

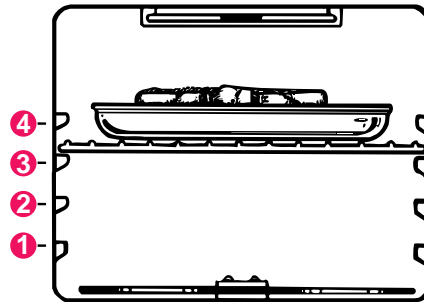

Broiling tips

- **Use** the broiler pan and grid for broiling. They are designed to drain excess liquid and grease away from the cooking surface to help prevent spatter, smoke, or fire.
- **Do not cover** the broiler grid with foil.
- **Place food** about 3" or more from the broil element.
- **To ensure** adequate grease drainage, do not use cookie sheets or similar pans for broiling.
- **After broiling, remove** the broiler pan from the oven when you remove the food. Drippings will bake on the pan if you leave it in the heated oven.

Energy saving tips

Although the energy used for cooking is usually a very small percentage of the total energy used in the home, cooking energy can be used efficiently. Here are some tips to help you save energy when using your cooking product:

- **Use** pans with flat bottoms, straight sides, and tight-fitting lids.
- **Match** the pan to the surface unit size.
- **Cook** with a minimum of liquid or grease to help shorten cooking time.
- **Preheat** pans only when recommended and for the shortest time possible.
- **Start** food on higher heat settings, then set surface unit control on low or off to finish cooking. Use retained heat for cooking when possible.
- **Use** the more efficient surface units instead of the oven when possible.
- **Turn on** the surface unit only after placing filled pan on the unit.
- **“Oven peeking”** may cause heat loss, longer cooking times, and unsatisfactory baking results. Rely on your timer to keep track of the cooking time.
- **Bake** cakes, pies, or cookies when oven is warm. Best time to bake is right after a meal has been cooked in the oven.
- **Preheat** the oven no longer than necessary.
- **Plan** your meals for the most efficient use of the range. When using the oven to cook one food, try to cook the rest of the meal in it also.
- **Do not preheat** when broiling, roasting, or cooking items such as casseroles.

Using the electronic MEALTIMER™ control

The electronic MEALTIMER control is designed to turn the oven on and off at times you set, even when you are not around.

Delayed time baking/roasting is ideal for foods which do not require a preheated oven, such as meats and casseroles. **Do not use delayed time cooking for cakes, cookies, etc. – they will not rise properly.**

Before using the electronic MEALTIMER control, make sure the clock is set to the correct time of day. (See “Setting the clock” on page 13.)

To start baking/roasting now and stop automatically:

1. **Position** the oven rack(s) properly and **put** food in the oven.

WARNING

Food Poisoning Hazard

Do not let food sit in oven more than one hour before or after cooking.

Failure to follow the above can result in death, food poisoning, or sickness.

continued on next page

USING YOUR RANGE

2. **Press** the Cook Time pad.



3. **Press** the Increase pad until the desired baking/roasting time shows on the display.



4. **Press** the Bake pad. The last oven temperature to be set appears on the display.

NOTE: If this step is not done, a tone will sound.



5. **Press** Increase or Decrease pad until the desired temperature shows on the display.

6. **When the oven starts to heat, ON** and the changing temperature (starting at 100°F) will be displayed. When the oven reaches the set temperature, a tone will sound.

NOTE: You can change the temperature setting any time during the Bake cycle by repeating Steps 4 and 5 above.

7. **Remove** food from the oven.

NOTE: Even though oven shuts off automatically, food continues cooking after controls are off.

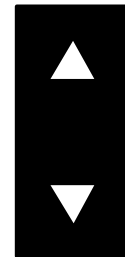

To delay start and stop automatically:

1. **Position** the oven rack(s) properly and **put** food in the oven.
2. **Press** the Cook Time pad.



3. **Press** the Increase pad until the desired baking/roasting time shows on the display.



(example for 3 hours)

4. **Press** the Stop Time pad. The time displayed will be the time of day plus the cook time. For example, if the current time of day is 2:00 and the cook time is 3 hours, the display will show 5:00.



(example for 5:00 stop time, before stop time is set)

5. **Press** the Increase pad to set the stop time. If you have set a 7:00 stop time and a 3-hour cook time, the oven will turn on at 4:00.



(example for 7:00 stop time)

continued on next page

USING YOUR RANGE

6. **Press** the Bake pad. The last oven temperature to be set appears on the display.

NOTE: If this step is not done, a tone will sound.



7. **Press** Increase or Decrease pad until the desired temperature shows on the display.



8. **At the set start time (4:00 in example above),** the oven will turn on automatically. When the oven starts to heat, ON and the changing temperature (starting at 100°F) will be displayed. When the oven reaches the set temperature, a tone will sound. The oven will continue to cook for the programmed 3 hours and shut off automatically at 7:00.

NOTE: You can change the temperature setting any time during the Bake cycle by repeating Steps 6 and 7 above.

9. **Remove** food from the oven.

NOTE: Even though oven shuts off automatically, foods continue cooking after controls are off. The low temperature zone of this range (between 150°F and 200°F) keeps hot, cooked foods warm.

To cancel the MEALTIMER™ control setting:

- **Press** Off/Cancel pad to return the display to the time of the day.

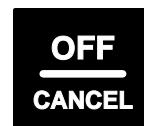

The oven vent

⚠ WARNING



Burn Hazard

Use pot holders when touching items left near oven vent.

Failure to do so can result in burns.

Hot air and moisture escape from the oven through a vent located at the back of the cooktop. The vent is needed for air circulation. **Do not block the vent by using extra large pans or covers.** You will get poor baking/roasting results.

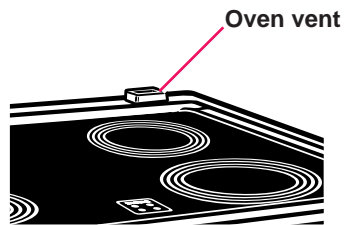

The storage drawer

You can remove the storage drawer to make it easier to clean under the range. **Use care when handling the drawer.**

Removing the storage drawer:

1. **Empty** drawer before removing. **Pull** drawer straight out to the first stop. **Lift** front and **pull out** to the second stop.
2. **Lift** back slightly and **slide** drawer all the way out.

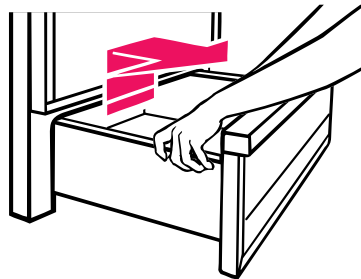

Replacing the storage drawer:

1. **Fit** ends of drawer slide rails into the drawer guides on both sides of opening.
2. **Lift** drawer front and **push in** until metal stops on drawer slide rails clear white stops on drawer guides. **Lift** drawer front again to clear second stop and **slide** drawer closed.

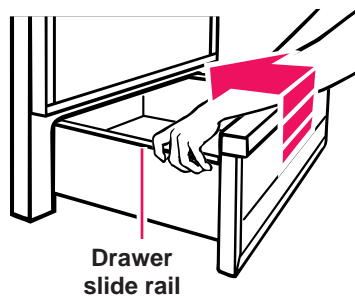

The anti-tip bracket

The range will not tip during normal use. However, tipping can occur if you apply too much force or weight to the open door without the anti-tip bracket properly secured.

	⚠ WARNING
	<p style="text-align: center;">Tip Over Hazard</p> <p>Connect anti-tip bracket to floor or wall. Reconnect anti-tip bracket, if the range is moved. Do not push down on the open oven door. Follow the Installation Instructions. Do not let children climb onto the oven door. Failure to do so can result in death, burns, or other injury.</p>

To verify the anti-tip bracket is engaged:

- **Grasp** rear of range and carefully try to tilt forward. If anti-tip bracket is attached to floor or wall correctly, range should not tilt forward.
- **See** Installation Instructions for further details.

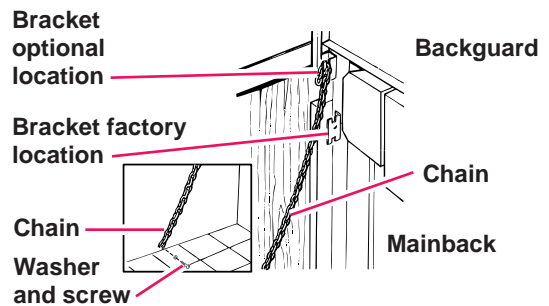

Using the Self-Cleaning Cycle

The Self-Cleaning cycle saves you from the toil and mess that often come with hand-cleaning the oven interior. Like the other functions of your oven, you operate the Self-Cleaning cycle with the easy-to-use electronic control. Please review the instructions in this section to keep your oven spotless.

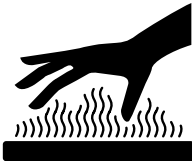
	<h2 style="text-align: center;">! WARNING</h2> <p style="text-align: center;">Burn Hazard</p> <p>Do not touch the oven during the Self-Cleaning cycle.</p> <p>Keep children away from oven during Self-Cleaning cycle.</p> <p>Do not use commercial oven cleaners in your oven.</p> <p>Failure to follow the above can result in burns, or illness from inhaling dangerous fumes.</p>
-----------------------------------------------------------------------------------	--------------------------------------------------------------------------------------------------------------------------------------------------------------------------------------------------------------------------------------------------------------------------------------------------------------------------------------------------------------------------------------------------------------------------

Before you start

Before you start the Self-Cleaning cycle, make sure you:

- **Hand-clean the areas shown.** They do not get hot enough during the cleaning cycle for soil to burn away. Use hot water and detergent or a soapy, steel-wool pad for cleaning.

NOTE: DO NOT clean, move or bend the seal. Poor cleaning, baking, and roasting may result.

- **Remove any pots and pans** being stored in the oven.

NOTE: You can clean the broiler pan and grid in the oven if you have first removed most of the soil by hand-cleaning or in a dishwasher. If most of the soil is not removed, too much smoking will occur.

- **Wipe out any loose soil or grease.** This will help reduce smoke during the Self-Cleaning cycle.
- **Remove the oven racks from the oven if you want them to remain shiny.** You can clean the oven racks in the Self-Cleaning cycle, but they will become harder to slide. (See page 32.) If you clean racks in the Self-Cleaning cycle, place them on the 2nd and 4th rack guides. (Guides are counted from bottom to top.)
- **Heat and odors** are normal during the Self-Cleaning cycle. Keep the kitchen well ventilated by opening a window or by turning on a vent hood or other kitchen vent during the cycle.

Hand-clean frame

DO NOT hand-clean seal

Hand-clean door around edge

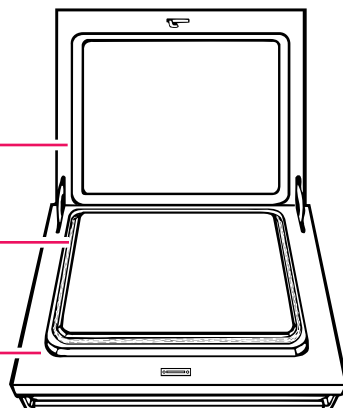

NOTES:

- **Do not block** the vent during the Self-Cleaning cycle. Air must move freely for best cleaning results.
- **Do not leave** plastic utensils near the vent. They may melt.
- **Do not leave** any foil in oven during the Self-Cleaning cycle. Foil could burn or melt and damage the oven surface.
- **To prolong bulb life,** leave the oven light off during the Self-Cleaning cycle.

Setting the controls

Make sure the clock is set to the correct time of day. (See "Setting the clock" on page 13.)

To start the Self-Cleaning cycle now:

1. Press the Clean pad. The display will show "----".



2. To set the cleaning time, press the Increase or Decrease pad until the desired cleaning time shows on the display. You can set the cleaning time anywhere between 2 and 4 hours.

- Use 2 hours for light soil.
- Use 3-4 hours for moderate to heavy soil.



3. Once you have set the cleaning time ON will appear on the display. The Self-Cleaning cycle will begin automatically within a few seconds.

To delay the start of Self-Cleaning cycle:

1. Press the Clean pad. The display will show "----".



2. To set the cleaning time, press the Increase or Decrease pad until the desired cleaning time shows on the display. You can set the cleaning time anywhere between 2 and 4 hours.

- Use 2 hours for light soil.
- Use 3-4 hours for moderate to heavy soil.

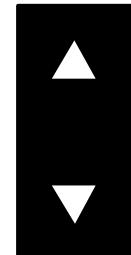

3. **Press** the Stop Time pad. The time displayed will be the time of day plus the cleaning time. For example, if the current time of day is 7:00 and the cleaning time is 3 hours, the display will show 10:00.



(example for 10:00 stop time, before stop time is set)

4. **Press** the Increase pad to set the stop time. If you have set a 12:00 stop time and a 3-hour cleaning time, the oven will turn on at 9:00.



(example for 12:00 stop time)

When the oven locks:

LOCK will be displayed and the door will be locked in position. You cannot open the oven door until the temperature drops below the lock temperature.

When the Self-Cleaning cycle is completed:

CLEAN goes out on the display and the oven will start cooling.

When the oven reaches normal baking/roasting temperatures:

LOCK goes out on the display and the door can be opened.

To stop the Self-Cleaning cycle at any time:

- Press the Off/Cancel pad.



Special tips

- **Keep** the kitchen well ventilated during the Self-Cleaning cycle to help get rid of heat, odors, and smoke.
- **After the oven is cool**, wipe up any residue or ash with a damp cloth or sponge. If any spots remain, clean with a mild abrasive cleanser or cleaning sponge.
- **Clean** the oven before it gets heavily soiled. Cleaning a very soiled oven takes longer and results in more smoke than usual.
- **If the Self-Cleaning cycle does not get the oven as clean as you expected**, the cycle may not have been set long enough or you may not have prepared the oven properly. Set the Self-Cleaning cycle longer the next time and hand-clean areas noted on page 25.

How the cycle works

The Self-Cleaning cycle uses very high heat to burn away soil and grease. During the cycle, the oven gets much hotter than it does for normal baking or broiling. This high heat breaks up the soil or grease and burns it away.

Your oven is preset for a 3-hour Self-Cleaning cycle. However, you can adjust the cycle time to the amount of soil in your oven. You can set the cycle anywhere between 2 and 4 hours. (See “Setting the controls” on page 26.)

The graph at the right is representative of a normal, 3-hour Self-Cleaning cycle. Note that the heating stops when the 3-hour setting is up, but it takes longer for the oven to cool enough to unlock.



Caring for Your Range

Your range is designed for easy care. You can do most cleaning with items found around your home. Cleaning your range whenever spills or soiling occurs will help to keep it looking and operating like new.

NOTE: Let cooktop cool before cleaning.

Cleaning the cooktop

This cooktop is designed for easy care. However, ceramic cooktops need to be maintained differently than standard electric open-coil elements. Foods spilled directly on the cooktop will not burn off as on open-coil elements. Because of this, the surface should be dust-free and soil-free before heating.

Your cooktop has been prepolished at the factory for improved protection and cleanability. The Cooktop Polishing Creme and razor scraper (both included with your range), and paper towels or a sponge, are all you need to clean your cooktop. For proper cleaning methods, please review “Cleaning tips” on page 30. Follow them after each use to ensure top performance and to preserve that uniquely elegant look.

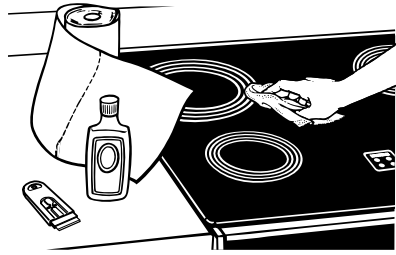

To avoid damaging the cooktop, follow these instructions:

- **Sugar spills and soils** (such as jellies and candy syrups) can cause pitting on the cooktop if not removed **while the ceramic surface is still warm**. Remove as soon as possible after the spill occurs.
- **Do not use** the cooktop as a cutting board.
- **Do not allow** anything that may melt (such as plastic or aluminum foil) to come in contact with the surface while it is hot.
- **Do not use** the ceramic cooktop to cook popcorn that comes in prepackaged aluminum containers. The container could leave aluminum marks on the cooktop that cannot be removed completely.
- **Do not use** steel wool, plastic cleaning pads, abrasive powdered cleansers, chlorine bleach, rust remover, ammonia, or glass cleaning products with ammonia. These could damage the cooktop surface.
- **Dropping** heavy or hard objects on the cooktop could crack it. Be careful with heavy skillets. Do not store jars or cans above the cooktop.

Cleaning tips

What to use:

- **Cooktop Polishing Creme (included with your range) with paper towel or clean, damp sponge** – This creme has been developed especially for cleaning and protecting your cooktop. When using, follow instructions on container.
- **Razor scraper** – Use to remove cooked-on soils from your ceramic cooktop. To avoid scratches, keep the razor blade as flat against the cooktop as possible. **Store razor blades out of reach of children.**

Steps to follow:

1. **Most spills** can be wiped off easily using a paper towel or clean, damp sponge as soon as Hot Surface Indicator Light(s) go off.
2. **For stubborn spills**, rub Cooktop Polishing Creme into cooked-on soil using a paper towel. If some soil remains, leave some creme on the spot(s) and follow Step 3.
3. **Carefully scrape** spots with the razor scraper.
4. **Finish** by polishing entire cooktop with Cooktop Polishing Creme and a paper towel.

Additional tips:

- **Remove dark streaks, specks, and discoloration** with Cooktop Polishing Creme.
- **Remove metal marks** (from copper or aluminum pans) with Cooktop Polishing Creme before heating the cooktop again. If heated before cleaning, metal marks may not come off.
- **Tiny scratches or abrasions do not affect cooking.** In time, these will become less visible as a result of cleaning. To prevent scratches and abrasions, use Cooktop Polishing Creme regularly.
- **Nonabrasive cleanser with damp paper towel or sponge** can be used as an alternative method for removing cooked-on soils. **Always rinse and dry your cooktop** thoroughly after using cleanser to prevent streaking or staining.

To order the Cooktop Polishing Creme (Part No. 3184477) or a razor scraper (Part No. 3183488), call 1-800-253-1301. You will hear a recording. Follow the steps to place an order.

Cleaning other range parts

Use the following table to help you clean the other parts of your range.

PART	WHAT TO USE	HOW TO CLEAN
Control knobs	Sponge and warm, soapy water	<ul style="list-style-type: none"> • Turn knobs to OFF and pull straight away from control panel. • Wash, rinse, and dry thoroughly. Do not soak. • Do not use steel wool or abrasive cleansers. They may damage the finish of the knobs. • Replace knobs. Make sure all knobs point to OFF.
Control panel	<p>Sponge and warm, soapy water</p> <p>OR</p> <p>Paper towel and spray glass cleaner</p>	<ul style="list-style-type: none"> • Wash, wipe with clean water, and dry thoroughly. • Do not use steel wool or abrasive cleansers. They may damage the finish. • Do not spray cleaner directly on panel. Apply cleaner to paper towel. <p>NOTE: Make sure you have not turned the oven on when cleaning panel. If you have, push the Off/Cancel pad.</p>
Exterior surfaces (other than cooktop and control panel)	Sponge and warm, soapy water	<ul style="list-style-type: none"> • Wash, wipe with clean water, and dry thoroughly. • Use nonabrasive, plastic scrubbing pad on heavily soiled areas. • Do not use abrasive or harsh cleansers. They may damage the finish.

continued on next page

CARING FOR YOUR RANGE

PART	WHAT TO USE	HOW TO CLEAN
Broiler pan and grid (clean after each use)	Steel-wool pad and warm, soapy water	<ul style="list-style-type: none"> Wash, rinse, and dry thoroughly. Do not clean in Self-Cleaning cycle. (See note on page 25.)
Oven racks	Steel-wool pad and warm, soapy water OR The Self-Cleaning cycle	<ul style="list-style-type: none"> Wash, rinse, and dry thoroughly. <p>OR</p> <ul style="list-style-type: none"> Leave in oven during Self-Cleaning cycle. <p>NOTE: Racks will permanently discolor and become harder to slide if left in oven during Self-Cleaning cycle. Apply a small amount of vegetable oil to the side rungs to aid sliding.</p>
Oven door glass	Paper towel and spray glass cleaner OR Warm, soapy water and a nonabrasive, plastic scrubbing pad	<ul style="list-style-type: none"> Make sure oven is cool. Follow directions provided with the cleaner. Wash, wipe with clean water, and dry thoroughly.
Oven cavity	Self-Cleaning cycle	<ul style="list-style-type: none"> See “Using the Self-Cleaning Cycle” on pages 25-28.

The oven light

To turn the light on, press the Oven Light Switch on the control panel.

To replace the oven light:

- Disconnect** appliance at the main power supply.
- Remove** the glass bulb cover in the back of the oven by screwing it out counter-clockwise.
- Remove** the light bulb from its socket. **Replace** the bulb with a 40-watt appliance bulb.
- Replace** the bulb cover by screwing it in clockwise. **Reconnect** appliance at the main power supply.

NOTE: To prolong bulb life, leave the oven light off during the Self-Cleaning cycle.

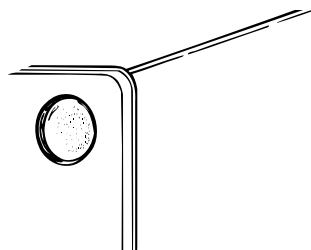
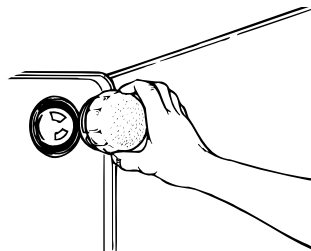

If You Need Assistance or Service

This section is designed to help you save the cost of a service call. Part 1 of this section outlines possible problems, their causes, and actions you can take to solve each problem. Parts 2 and 3 tell you what to do if you still need assistance or service. When calling our Consumer Assistance Center for help or calling for service, please provide a detailed description of the problem, your appliance's complete model and serial numbers and the purchase date. (See page 3.) This information will help us respond properly to your request.

1. Before calling for assistance ...

Performance problems often result from little things you can find and fix without tools of any kind. Please check the chart below for problems you can fix. It could save you the cost of a service call.

PROBLEM	POSSIBLE CAUSE	SOLUTION
Nothing will operate	The unit is not wired into a live circuit with proper voltage. A household fuse has blown or a circuit breaker has tripped.	Wire the unit into a live circuit with proper voltage. (See Installation Instructions.) Replace household fuse or reset circuit breaker.
The oven will not operate	You have not set the electronic control correctly. You have programmed a delayed start time.	Refer to pages 12-22 for setting the electronic control. Wait for the start time to be reached or cancel and reset the controls.
The surface units will not operate	A household fuse has blown or a circuit breaker has tripped. You are not setting the control knobs correctly.	Replace household fuse or reset circuit breaker. Push control knobs in before turning to a setting.
Control knob(s) will not turn	You are not pushing in before turning.	Push control knob(s) in before turning to a setting.
The Self-Cleaning cycle will not operate	The range clock does not show the correct time of day. You have programmed a delayed start time.	Reset clock to show the correct time of day. (See page 13.) Wait for the start time to be reached or cancel and reset the controls.

continued on next page

IF YOU NEED ASSISTANCE OR SERVICE

PROBLEM	POSSIBLE CAUSE	SOLUTION
<p>Cooking results are not what you expected</p>	<p>The range is not level.</p> <p>The oven temperature seems too low or too high.</p> <p>You have not preheated the oven as the recipe calls for.</p> <p>The recipe you are using may need to be altered to improve the taste or appearance of the food.</p> <p>The pan used is not the type or size recommended in the recipe.</p> <p>There is not proper air circulation around pan when baking.</p> <p>Cooking utensil does not fit the surface unit being used.</p>	<p>Level range. (See Installation Instructions.)</p> <p>Adjusting the oven temperature control. (See “Adjusting the oven temperature control” on page 16.)</p> <p>Preheat oven when called for in recipe.</p> <p>Alter recipe as needed.</p> <p>Refer to a reliable cookbook for recommended pan type and size.</p> <p>Allow 1½ to 2 inches (4-5 cm) of air space on all sides of pan.</p> <p>Pan should be the same size or slightly larger than surface unit being used.</p>
<p>The display shows “PF”</p>	<p>There has been a power failure.</p>	<p>Reset the clock. (See page 13.)</p>
<p>“F-” shows on the display</p>		<p>Call for service. (See Step 3 on page 35.)</p>

2. If you need assistance ...

Call the Whirlpool Consumer Assistance Center telephone number. Dial toll-free from anywhere in the U.S.A.

1-800-253-1301

and talk with one of our trained consultants. The consultant can instruct you in how to obtain satisfactory operation from your appliance or, if service is necessary, recommend a qualified service company in your area.

If you prefer, write to:

Whirlpool Brand Home Appliances
Consumer Assistance Center
c/o Correspondence Dept.
2000 North M-63
Benton Harbor, MI 49022-2692

Please include a daytime phone number in your correspondence.

3. If you need service ...



Whirlpool has a nationwide network of authorized Whirlpool service companies.

Whirlpool service technicians are trained to fulfill the product warranty and provide after-warranty service, anywhere in the United States. To locate the authorized Whirlpool service company in your area, call our Consumer Assistance Center telephone number (see Step 2) or look in your telephone directory Yellow Pages under:

• APPLIANCE-HOUSEHOLD-MAJOR, SERVICE & REPAIR

- See: Whirlpool Appliances or Authorized Whirlpool Service
(Example: XYZ Service Co.)

• WASHING MACHINES & DRYERS, SERVICE & REPAIR

- See: Whirlpool Appliances or Authorized Whirlpool Service
(Example: XYZ Service Co.)

4. If you need FSP® replacement parts ...

FSP is a registered trademark of Whirlpool Corporation for quality parts. Look for this symbol of quality whenever you need a replacement part for your WHIRLPOOL® appliance. FSP replacement parts will fit right and work right, because they are made to the same exacting specifications used to build every new WHIRLPOOL appliance.

To locate FSP replacement parts in your area, refer to Step 3 above or call the Whirlpool Consumer Assistance Center number in Step 2.

5. If you are not satisfied with how the problem was solved ...

- Contact the Major Appliance Consumer Action Program (MACAP). MACAP is a group of independent consumer experts that voices consumer views at the highest levels of the major appliance industry.
- Contact MACAP only when the dealer, authorized servicer, and Whirlpool have failed to resolve your problem.

Major Appliance Consumer Action Program
20 North Wacker Drive
Chicago, IL 60606

- MACAP will in turn inform us of your action.

WHIRLPOOL®

CLEANTOP® Electric Range

Warranty

LENGTH OF WARRANTY	WHIRLPOOL WILL PAY FOR
FULL ONE-YEAR WARRANTY FROM DATE OF PURCHASE	FSP® replacement parts and repair labor to correct defects in materials or workmanship. Service must be provided by an authorized Whirlpool service company.
FULL FIVE-YEAR WARRANTY FROM DATE OF PURCHASE	FSP replacement parts and repair labor for CLEANTOP ceramic cooktop to the original purchaser of this product. Whirlpool warrants that: <ul style="list-style-type: none"> – The ceramic cooktop will not discolor – The ceramic cooktop pattern will not wear off – The ceramic cooktop will not crack due to thermal shock – The surface units will not burn out
LIMITED WARRANTY FOR LIFE OF THE PRODUCT SECOND YEAR THROUGH LIFE OF PRODUCT FROM DATE OF PURCHASE	FSP replacement parts for control knobs.
WHIRLPOOL WILL NOT PAY FOR	
<p>A. Service calls to:</p> <ol style="list-style-type: none"> 1. Correct the installation of your range. 2. Instruct you how to use your range. 3. Replace house fuses or correct house wiring. 4. Replace owner-accessible light bulbs. <p>B. Repairs when your range is used in other than normal, single-family household use.</p> <p>C. Pickup and delivery. Your range is designed to be repaired in the home.</p> <p>D. Damage to your range caused by accident, misuse, fire, flood, acts of God, or use of products not approved by Whirlpool.</p> <p>E. Any labor costs during limited warranty.</p> <p>F. Repairs to CLEANTOP ceramic cooktop if it has not been cared for as recommended in this Use and Care Guide.</p> <p>G. Repairs to parts or systems caused by unauthorized modifications made to the appliance.</p>	

7/95

WHIRLPOOL CORPORATION SHALL NOT BE LIABLE FOR INCIDENTAL OR CONSEQUENTIAL DAMAGES. Some states do not allow the exclusion or limitation of incidental or consequential damages, so this exclusion or limitation may not apply to you. This warranty gives you specific legal rights, and you may also have other rights which vary from state to state.

Outside the United States, a different warranty may apply. For details, please contact your authorized Whirlpool dealer.

If you need service, first see the “If You Need Assistance or Service” section of this book. After checking “If You Need Assistance or Service,” additional help can be found by calling our Consumer Assistance Center telephone number, **1-800-253-1301**, from anywhere in the U.S.A.

PART NO. 229C4020P026-1/4389867